



2427D

Alicates de boca semirredonda y punta curvada 45°, con mangos monomateriales



DETALLES DEL PRODUCTO

- Mangos de polipropileno
 - Capacidad de corte: 2.5 mm a 3 mm de Cu, 1.8 mm de Fe, 1.4 mm a 1.6 mm de Fe +
 - -
 - Mordazas de forma redonda y serradas para agarrar materiales planos y redondos con gran accesibilidad en espacios reducidos
 - Mordazas dobladas, con bordes de corte endurecidos para cortar alambre blando y duro
- Aleación de acero de alto rendimiento
 - Acabado fosfatado, tratamiento anticorrosión
 - Normas: ISO 5745
 - -

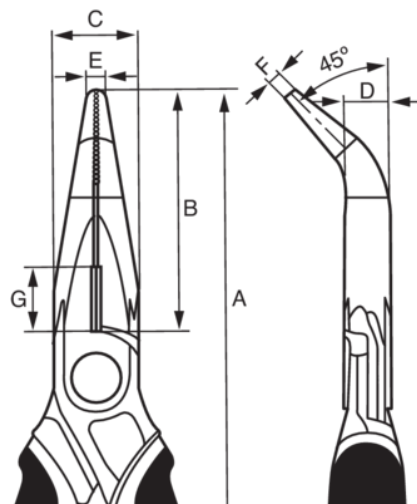





Follow the Fish!







ATRIBUTOS DE PRODUCTO

Producto: 2427 D-160

A	160 mm	B	46 mm	C	16.5 mm
D	8.9 mm	E	3 mm	F	2.5 mm
G	12 mm	 3.0 mm	 1.8 mm		
	1.6 mm		160 g		

Producto: 2427 D-200

A	200 mm	B	65 mm	C	17 mm
D	9.4 mm	E	3 mm	F	2.5 mm
G	12 mm	 3.0 mm	 1.8 mm		
	1.6 mm		170 g		

